



## NX LEAD CRYSTAL BATTERY

### MAIN INFORMATION / INFORMATIONS GÉNÉRALES

<b>BRAND</b>	MARQUE	NX
<b>TECHNOLOGY</b>	TECHNOLOGIE	LEAD CRYSTAL
<b>NOMINAL VOLTAGE</b>	TENSION NOMINALE	12V
<b>NOMINAL CAPACITY</b>	CAPACITÉ NOMINALE 25°C	
<b>C120</b>		14,4AH
<b>C20</b>		13,2AH
<b>C10</b>		12AH
<b>DIMENSIONS (±2mm)</b>	DIMENSIONS (±2mm)	
• <b>Length / Longueur</b>		151mm
• <b>Width / Largeur</b>		99mm
• <b>Height / Hauteur</b>		94mm
• <b>TOTAL HEIGHT WITH TERMINALS / Hauteur totale (avec cosSES)</b>		96mm
<b>WEIGHT (±2%)</b>	POIDS (±2%)	4,1Kg
<b>POLARITY</b>	POLARITÉ	+ -
<b>TERMINAL</b>	TYPE DE COSSES	M5-F



### TECHNICAL INFORMATION / INFORMATIONS TECHNIQUES

<b>MAX DISCHARGE CURRENT</b>	COURANT DE DÉCHARGE MAX	120A (5S)
<b>INTERNAL RESISTANCE</b>	RÉSISTANCE INTERNE 25°C	16 mΩ
<b>SELF DISCHARGE</b>	AUTO DÉCHARGE	
<b>3 months / 3 mois</b>		95%
<b>6 months / 6 mois</b>		85%
<b>12 months / 12 mois</b>		80%
<b>FLOAT CHARGING VOLTAGE</b>	TENSION DE CHARGE EN FLOATING 25°C	13,5V - 13,6V
<b>CYCLING CHARGING VOLTAGE</b>	TENSION DE CHARGE EN CYCLAGE	14,4V - 14,5V

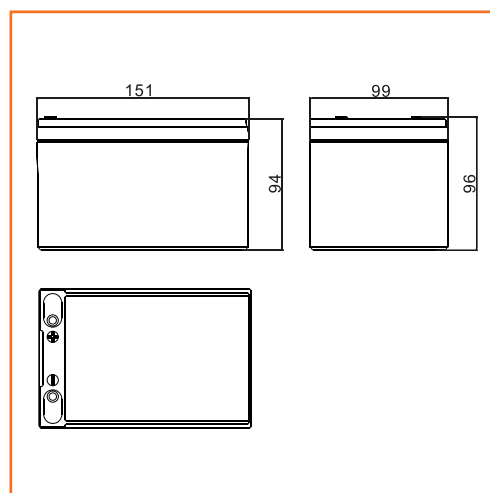

### DISCHARGE CURRENT AND CUT OFF VOLTAGE / COURANT DE DECHARGE ET TENSION DE FIN DE DECHARGE

DISCHARGE CURRENT / COURANT DE DÉCHARGE (A)	DISCHARGE CUT OFF VOLTAGE / TENSION DE FIN DE DÉCHARGE (V)
0,01C	11,40
0,01C - 0,05C	11,10
0,05C - 0,1C	10,80
0,1C - 0,5C	10,50
0,5C - 1C	10,20
1C - 3C	9,60
3C - 6C	9,00
6C - 10C	7,80
10C	7,20

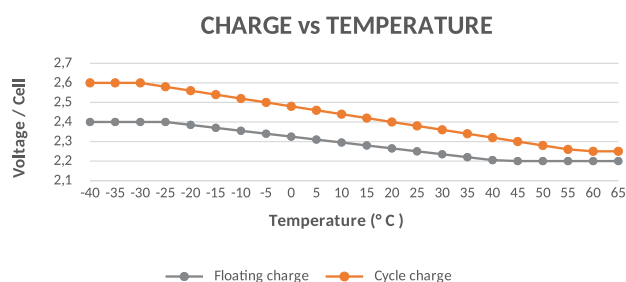

## PRODUCT DESCRIPTION / DESCRIPTION DU PRODUIT

**UK:** Lead Crystal batteries offer significantly better performance than traditional lead acid battery technologies. Totally sealed, Lead Crystal batteries use a new type of electrolyte that crystallizes when charged/discharged. This new electrolyte technology (non-corrosive SiO<sub>2</sub> acid) combined with the use of high quality plates (high-purity lead calcium selenium) considerably improves battery performance.

**FR:** Les batteries Lead Crystal offrent des performances nettement supérieures aux technologies classiques de batterie plomb. Totalement étanches, les batteries au plomb Crystal utilisent un nouveau type d'électrolyte qui se cristallise au fur et à mesure des cycles. Cette nouvelle technologie d'électrolyte (acide SiO<sub>2</sub> non corrosif) combiné à l'usage de plaques de grande qualité (plomb pur calcium sélénium) permet d'améliorer considérablement les performances des batteries.

## FEATURES / CARACTERISTIQUES PRINCIPALES

### - Greenest lead acid battery:

Less acid, no cadmium, no antimony. NX lead crystal batteries are up to 99% recyclable and are classified as non-hazardous goods for transport.

### - Long lifespan: Up to 11 years in floating and 2000 cycles at 50% DOD

### - Good recovery from deep Cycle : Lead crystal batteries can be 100% discharged

### - Long shelf life / Low self-discharge:

Up to 2 years in storage without refresh charging

### - Very short recharge time / Higher availability:

Charge up to 3 time faster than other lead acid battery technologies

### - Safest Lead Acid Technology:

- Extreme temperature resistance (-40°C to +65°C)
- High resistance to vibration
- Operation in any direction
- Sealed and Maintenance Free

### - High Rate discharge : Excellent high rate discharge

### - Batterie plomb la plus écologique:

Moins d'acide, pas de cadmium, pas d'antimoine. Les batteries NX Lead Crystal sont recyclables jusqu'à 99 % et sont classées comme marchandises non dangereuses pour le transport.

### - Longue durée de vie : Jusqu'à 11 ans en floating et 2000 cycles à 50% de décharge.

### - Performance en décharge profonde: Supporte des profondeurs de décharge jusqu'à 100%

### - Faible autodécharge / Longue durée de stockage : Les batteries lead crystal peuvent être stockées jusqu'à 2 ans sans recharge.

### - Recharge rapide / Plus grande disponibilité :

Charge jusqu'à 3 fois plus rapide que les autres technologies de batteries au plomb

### - Technologie Haute fiabilité:

- Bonne résistance aux températures extrêmes (-40°C à +65°C)
- Bonne résistance aux vibrations,
- Fonctionnement dans n'importe quel sens
- Étanche et sans entretien

### - Décharge rapide : Excellentes performances pour des usages à débit élevé (UPS par exemple)

## CAUTION / AVERTISSEMENT

### - Operation in any orientation except permanently inverted.

### - Continuous use of the battery in a permanently inverted position may adversely affect battery life and performance.

### - End-of-life NX batteries must be recycled in accordance with current legislation.

### - Fonctionnement dans n'importe quel sens sauf en utilisation inversée continue.

### - L'utilisation continue de la batterie en position inversée peut impacter négativement sa durée de vie et ses performances.

### - Les batteries NX en fin de vie doivent être recyclées selon la législation en vigueur.

## APPLICATIONS / APPLICATIONS

### Solar and renewable energies

### Leisure (marine, camping car, etc.)

### Cyclic use (Mobility scooters, Electric vehicles, Golf carts, etc.)

### Medical

### Emergency lighting

### Railway signal

### Alarm and security system

### Aircraft signal

### Electronic devices and equipment

### Emergency backup

### Power supply

### Solaire et énergies renouvelables

### Servitude (marine, camping car, etc...)

### Usage cyclique (Fauteuil roulant, Véhicule électrique, Golf etc...)

### Médical

### Éclairage de secours

### Signalisation ferroviaire

### Alarme et sécurité

### Signal d'avion

### Appareils et équipements électroniques

### Alimentation de secours

### Réserve d'énergie

\* Non exhaustive list / Liste non-exhaustive



**CONSTANT CURRENT DISCHARGE CHARACTERISTICS / CARACTÉRISTIQUES DE DÉCHARGE À COURANT CONSTANT**

Cut off voltage per cell	5min	15min	30min	45min	1h	2h	3h	4h	5h	6h	8h	10h	12h	20h	24h
1.60V	32.4	20.6	13.6	10.2	7.62	5.00	3.63	2.82	2.40	2.06	1.56	1.26	1.06	0.66	0.55
1.67V	27.9	18.7	12.6	9.72	7.55	4.77	3.45	2.79	2.28	2.04	1.53	1.23	1.06	0.66	0.55
1.70V	26.6	18.1	12.2	9.60	7.49	4.70	3.38	2.77	2.26	2.02	1.52	1.22	1.06	0.66	0.55
1.75V	24.2	17.0	11.7	9.22	7.34	4.52	3.28	2.70	2.19	1.98	1.50	1.21	1.05	0.66	0.55
1.80V	21.4	15.5	11.3	8.89	7.20	4.36	3.24	2.65	2.14	1.93	1.46	1.20	1.03	0.66	0.55
1.83V	18.7	14.2	10.4	8.26	6.88	4.17	3.12	2.54	2.05	1.86	1.41	1.16	1.00	0.65	0.53
1.85V	15.9	12.9	9.60	7.64	6.49	3.99	3.00	2.44	1.96	1.80	1.36	1.13	0.97	0.65	0.52

Units: Amperes (25°C, 77°F)

**CONSTANT CURRENT DISCHARGE CHARACTERISTICS / CARACTÉRISTIQUES DE DÉCHARGE À COURANT CONSTANT**

Cut off voltage per cell	5min	15min	30min	45min	1h	2h	3h	4h	5h	6h	8h	10h	12h	20h	24h
1.60V	53.30	35.89	24.56	18.72	15.47	9.17	6.64	5.36	4.45	4.00	3.03	2.47	2.07	1.29	1.08
1.67V	47.62	33.46	22.99	17.91	15.11	9.02	6.54	5.34	4.37	3.96	2.97	2.41	2.07	1.29	1.08
1.70V	46.08	32.59	22.36	17.72	14.68	8.93	6.45	5.30	4.34	3.93	2.96	2.39	2.07	1.28	1.08
1.75V	39.37	30.64	21.63	17.18	14.27	8.63	6.30	5.22	4.23	3.87	2.90	2.36	2.07	1.27	1.08
1.80V	35.21	28.24	20.89	16.63	13.74	8.35	6.23	5.12	4.12	3.81	2.85	2.34	2.01	1.26	1.07
1.83V	33.19	26.15	19.51	15.58	13.05	8.04	6.01	4.96	3.98	3.71	2.76	2.28	1.96	1.25	1.05
1.85V	29.55	24.05	18.13	14.54	12.37	7.73	5.80	4.78	3.83	3.60	2.66	2.22	1.91	1.25	1.02

Units: Watts per cell (25°C, 77°F)

**CHARGE AND DISCHARGE CURVES / COURBES DE CHARGE ET DÉCHARGE**

Temperature and float service life / Température et durée de vie

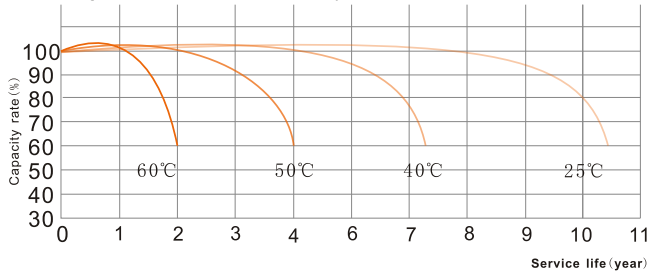

Temperature and discharge capacity / Température et capacité de décharge

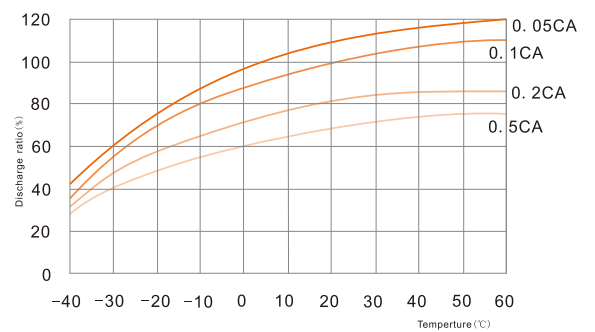

Discharge characteristics 77°F (25°C) / Caractéristiques de décharge 77°F (25°C)

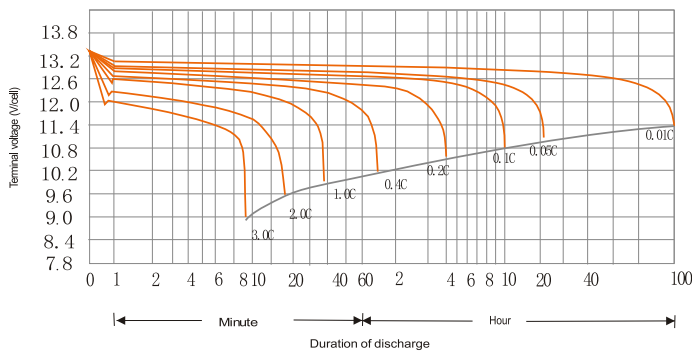

Float service life / Durée de vie en floating

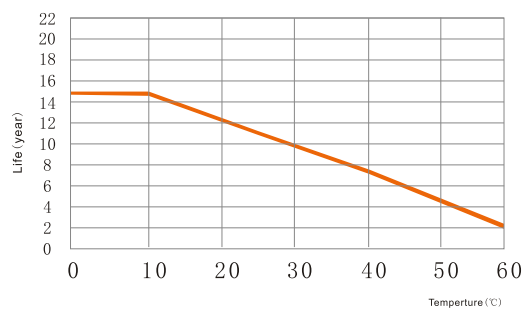

Charge characteristics 77°F (25°C) / Caractéristiques de charge 77°F (25°C)

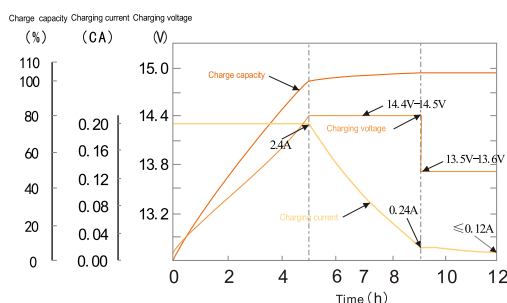

Cycle life curves (25°C) / Courbes de cycle de vie (25°C)  
Discharge at 0.1C / Cut off voltage 1.8V by cell

